

Table of Contents

1.1	Index of Tables.....	2
1.2	Index of Figures	2
1.3	Introduction	3
1.4	Transportation, Handling, & Storage	3
	Inspection.....	3
	Unloading & Storing	3
	Moving & Stringing	4
1.5	Trench Excavation	5
	Unstable Trench Walls	6
1.6	Foundations	7
	Unyielding/Hard Foundations	8
	Transition from Hard to Soft Foundations	8
	Foundation near Manhole or Catch Basin Structures	8
1.7	Bedding.....	9
1.8	Laying Pipe	9
1.9	Backfilling.....	11
	Compaction.....	14
	Minimum Cover Height.....	16
	Maximum Cover Height.....	17
1.10	Additional Considerations.....	17
	Geotextiles	17
	Dewatering.....	17
	Groundwater/Pipe Flotation.....	18
	Field Modifications/Connections.....	18
	Sealing Vent Tubes.....	18
	Vertical Installations	18
	Parallel Pipe Installation	18
	Soil Jetting	19
	Deflection Testing	19
1.11	Summary.....	21



1.1 Index of Tables

Table 1: Minimum Recommended Trench Widths (ASTM D2321) 6

Table 2: ASTM and AASHTO Soil Properties 12

Table 3: Backfill Placement and Compaction Recommendations..... 14

Table 4: Compaction Effort and Equipment..... 15

Table 5: Minimum Cover Heights 16

Table 6: Minimum Cover for Temporary Construction Loads 17

Table 7: Parallel Pipe Installation Spacing 19

Table 8: 7.5% Deflection Dimensions for Base Diameter 20

Table 9: 5% Deflection Dimensions for Base Diameter 21

1.2 Index of Figures

Figure 1: Proper Stacking Alignment..... 4

Figure 2: Lifting Small Diameter (<18") Pipe 4

Figure 3: Lifting Large Diameter Pipe..... 5

Figure 4: Typical Sub-Trench Installation 6

Figure 5: Modified Foundation 7

Figure 6: Typical Structure Connection 8

Figure 7: Bedding Placement..... 9

Figure 8: Cleaning Sealing Surfaces of Pipe..... 9

Figure 9: Integral Bell and Spigot Connection 10

Figure 10: Installing Small Diameter Pipe 10

Figure 11: Installing Large Diameter Pipe with Sling 10

Figure 12: Installing Large Diameter Pipe with Stub..... 11

Figure 13: Typical Trench Installation 13

Figure 14: Typical Compaction Equipment..... 16

Figure 15: Typical Parallel Pipe Installation..... 19

Figure 16: Typical Mandrel 20



1.3 Introduction

There are a wide variety of pipe materials used in buried applications for the conveyance or storage of effluent. Most pipes may be divided into two basic classes: rigid or flexible. While rigid and flexible pipe may behave differently under installed conditions, the quality and method of installation is equally important for the successful long-term performance of either type of buried structure. When considering any pipe material, the resultant strength of the system is dependent on the pipe itself and the soil envelope as the two components interact to form the pipe/soil structure and collectively support the loads.

The recommendations contained in this installation section are based on ASTM D2321 “*Standard Practice for Underground Installation of Thermoplastic Pipe for Sewers and other Gravity-Flow Applications*”. This section discusses the job-site handling, trench excavation, backfill selection and placement as well as several other product and installation specifications.

1.4 Transportation, Handling, & Storage

Thermoplastic pipe such as High-Density Polyethylene (HDPE) and Polypropylene (PP) exhibit properties which make it ideal for use in buried applications. Thermoplastic pipe is lightweight making it easy to handle and manipulate by hand or with light-duty equipment. It is also very durable and generally resistant to impact, UV degradation, and most chemicals. However, as with any pipe product, there are some basic precautions that must be taken to reduce the likelihood of damage and to ensure trouble free performance. This document addresses measures to help ensure the pipe is not damaged before, during and after installation.

Inspection

Once the pipe is received on the job site, and prior to final acceptance, an inspection should be completed to ensure all products are correct, accounted for, and undamaged. All Prinsco pipe is marked with either an identification sticker, tag, or label code printed on the pipe that lists the product name, nominal size, and governing standards.

Unloading & Storing

Prior to unloading the pipe, a designated area on the jobsite should be reserved for the storage of pipe materials. The area should be flat and free of debris and hazards, including large rocks, construction material, and harmful chemicals. The area should also be located far enough away from construction traffic to avoid potential contact.

Prinsco pipe is typically delivered in one of two ways; either in loose form or palletized depending on the type and quantity of pipe. Non-palletized pipe can be unloaded by carefully rolling the pipe onto the forks of a front-end loader, and then onto the ground. Do not use forks directly inside the pipe as it may cause damage. Alternatively, the pipe can also be removed with the use of a sling or cable.

Unloading pallets can be done with a backhoe and a nylon sling or cable, or with the use of a forklift. The pallets should be picked with the slings wrapped around the pallets. Do not run the forks too far under the pallets, since the fork ends may strike adjacent pallets causing damage or push other pallets off opposite side of truck.

Pipe that is palletized can be left on the pallets until it will be installed. Pipe that is equipped with bell ends should be stacked in alternating directions, as shown in Figure 1, to reduce the possibility of bell deformation.

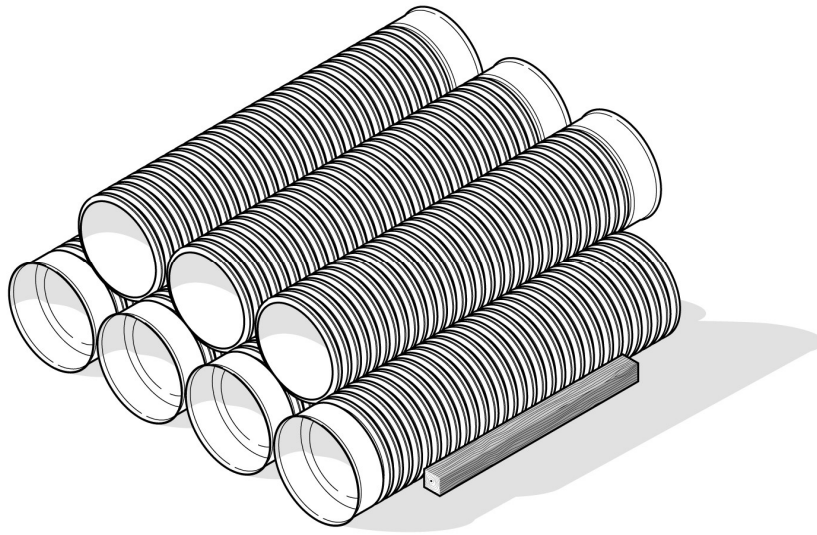

Figure 1: Proper Stacking Alignment

Also pipe with factory installed gaskets should be positioned so that the gaskets are between the corrugations on the adjacent pipe. Additional fittings, gaskets, and other accessories should be stored in a safe and convenient location as well.

Moving & Stringing

HDPE and HP pipe are relatively lightweight when compared to alternative pipe materials; however, unloading and handling can still be dangerous. Lifting smaller diameter (4"-18") pipe can typically be done by hand on either end of the pipe as shown in Figure 2.

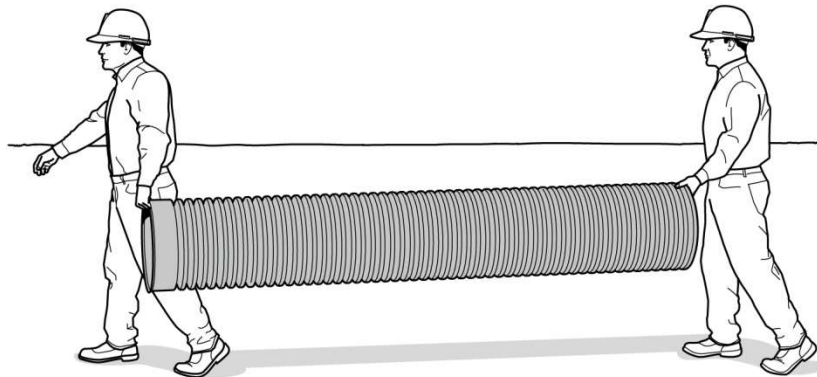

Figure 2: Lifting Small Diameter (<18") Pipe

Lifting larger diameter pipe (24" & up) will typically require the use of backhoe or other equipment. The pipe should be lifted evenly with a nylon sling or cable so that the pipe doesn't drag on the ground (Figure 3). Using bare chains or metal cables could potentially abrade the pipe and their use is not recommended.

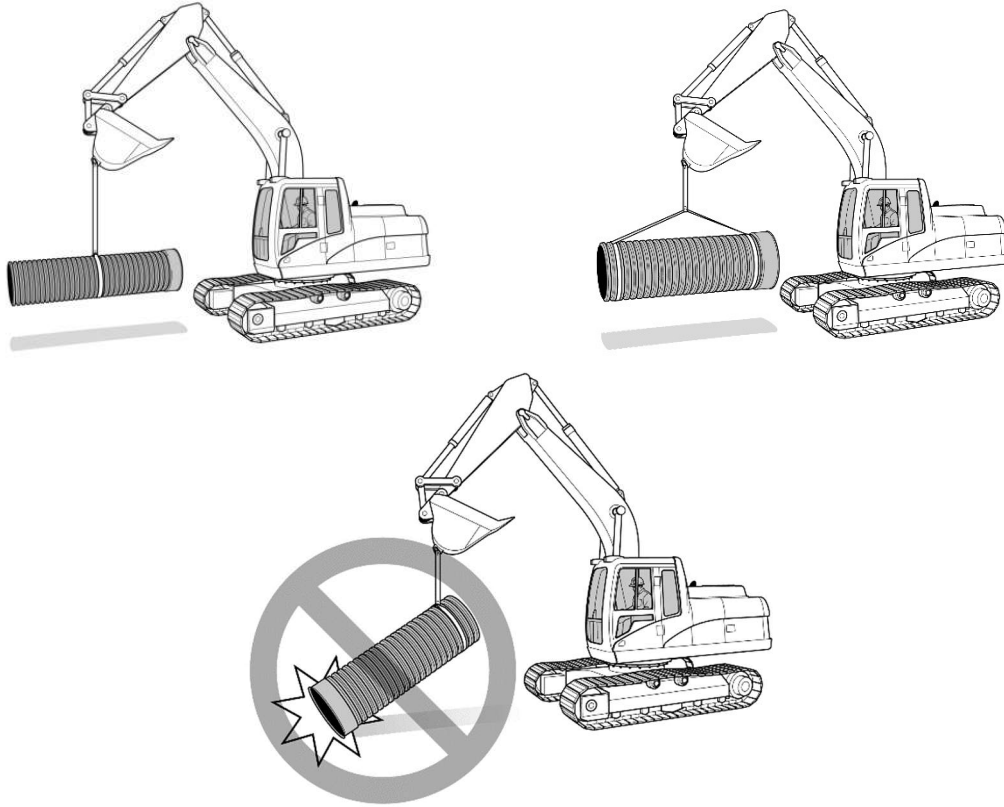

Figure 3: Lifting Large Diameter Pipe

“Stringing” or laying out the pipe along the proposed trench line is a commonly used practice which allows the pipe to be picked up and installed in one operation. The pipe should be strung out in a way that does not interfere with the excavation process. Blocks and supports should be used to prevent the pipe from rolling or deforming.

1.5 Trench Excavation

Due to the inherent hazards associated with trench excavation, special precautions should be taken. All Federal Occupational Safety and Health Administration (OSHA), State and Local safety requirements should be followed.

First and foremost, trenches must be excavated in such a manner that the walls will remain stable under all working conditions. Trench walls should be sloped or supported in conformance with all local, state, and national safety guidelines. For safety concerns, only the amount of trench that can be safely maintained should be opened. The trench width should be as narrow as possible to take advantage of the natural strength of the consolidated in-situ soil, while still allowing enough room for proper backfill placement and use of compaction equipment. Using guidelines set by ASTM D2321 and AASHTO Bridge Construction Specifications Section 30, Princo recommends the following trench widths based on pipe diameter:



Table 1: Minimum Recommended Trench Widths (ASTM D2321)

Pipe Diameter (in)	Min. Trench Width (in)
4	21
6	23
8	26
10	28
12	30
15	34
18	39
24	47
30	56
36	63
42	72
48	80
60	96

Trench widths for smaller diameter pipe (10” and smaller) are largely dependent on the smallest backhoe bucket available for excavation and will often exceed the widths recommended by the above mentioned requirements.

Unstable Trench Walls

Due to the unstable nature of some native soils, the trench may require over-excavation to prevent collapse. In these cases, the trench width shall be determined based on an evaluation of the in-situ soil and the anticipated loading. Alternatively, a trench box may be used to support the trench walls and provide a safe work area during the pipe laying process. Depending on the trench box design, a sub-trench may need to be constructed to avoid contact between the box and the pipeline. All local, state, and national safety guidelines should be followed when using trench boxes and sub-trenches. An example of a sub-trench is shown Figure 4.

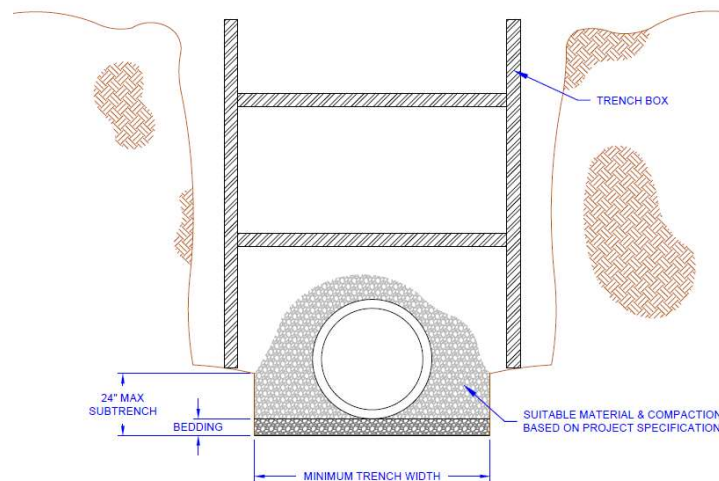

Figure 4: Typical Sub-Trench Installation



When working with trench boxes, it is critical to prevent disruption of the pipe installation while moving the trench box. If the trench box cannot be dragged without disrupting the pipe or initial backfill, it must be lifted in sections.

Water inside of the trench should be controlled before and during the pipe installation. The pipe should only be installed during dry conditions, never with running or standing water in the trench bottom. This may require control of surface and subsurface water sources by the following methods: sump pumps, wells or well points, drainage blankets, water-tight sheathing, and/or sheeting. Control of water sources should be maintained until initial backfill has been installed and there is an adequate amount of final backfill to prevent floatation. The use of anti-floatation restraints such as collars or anchors may be used, if deemed necessary. It should be noted that OSHA standards change from time to time. In the event any of these recommendations are in conflict with OSHA, state and local safety requirements or specific site conditions warrant alternative safety precautions, contact a qualified engineer.

1.6 Foundations

Just like the trench walls, the soil at the bottom of the trench, referred to as the foundation, is a critical part of the installation. The foundation material must be supportive and stable, to prevent excessive settlement. In many instances the in-situ soil is stable and provides a suitable foundation. Typically, a foundation is considered stable if a person can walk over the soil without sinking in or feeling the soil move beneath them. If unstable soil, such as muck, is encountered, a typical corrective measure is to remove and replace the unstable soil. However, there are several methods of improving the foundation prior to installation depending on the soil conditions present:

- **Reinforce** – Soft soils are reinforced by adding dry soil, stabilizing geotextile or geogrid materials, or lime and then compacting for stabilization.
- **Displace** – Soupy soils are displaced by placing an overburden material such as large aggregate in the bottom until the foundation is consolidated and stabilized.
- **Restore** – Loose soils can be restored by compacting to a greater density.
- **Remove** – Existing soils that are unusable should be completely excavated and replaced with a suitable material.

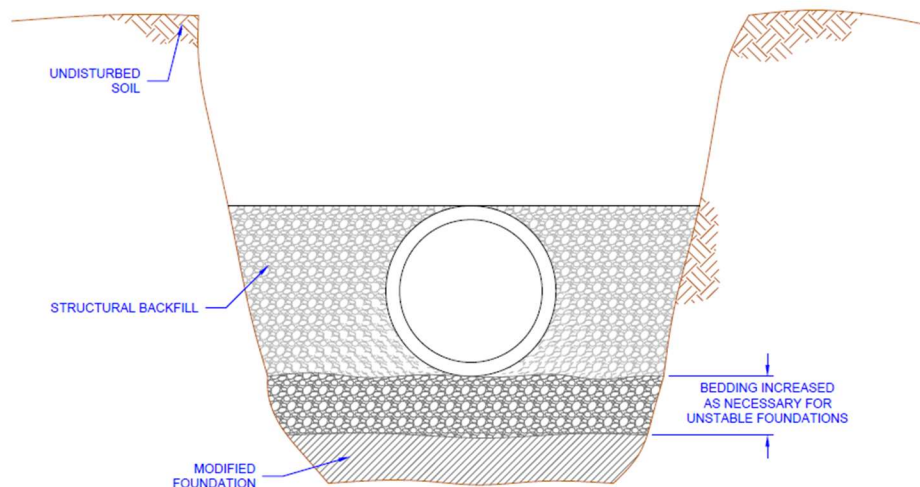

Figure 5: Modified Foundation

Each project will be unique, and the method and material used to construct the foundation should be chosen by a geotechnical engineer.



Unyielding/Hard Foundations

Unyielding materials, such as rock, in the trench bottom also pose a potential problem. To protect the pipe, bedding depth should be increased to 6"-10" as directed by a geotechnical engineer. Over-excavation of the trench may be required to accommodate the increased bedding while still achieving the desired line and grade.

Transition from Hard to Soft Foundations

In a situation where a hard foundation adjoins a soft foundation, there is potential for damage to the pipe. The dissimilar foundations may settle at different rates and result in depressions. To compensate for this, short sections of pipe with joints or couplers could be used at this transition point to better absorb the differential settlement. This is represented as an installation best practice and not a requirement.

Foundation near Manhole or Catch Basin Structures

Trench construction involving connection to structures, such as manholes or catch basins, will typically require over-excavation. The foundation in these cases will need to be built to grade with compacted structural fill or a controlled low strength material (CLSM). Connections to structures can be made in a number of ways dependent on the joint performance requirements and installation practices. As a best practice, a structure adapter should also be used to allow for some differential settling without causing strain on the pipe structure. As a recommended professional procedure, the first joint should be between 18"-36" from the structure connection to account for the concerns stated in this paragraph and the 'Transition from Hard to Soft Foundations' section above. Although not a requirement, this exercise will reduce the risks related with imperfect installation.

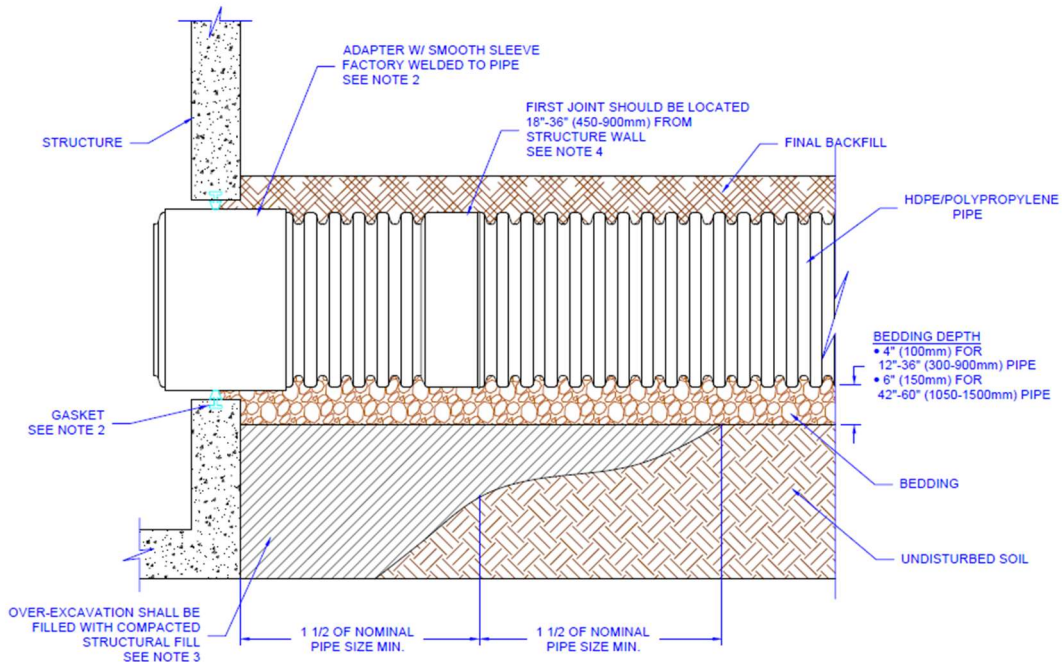

Figure 6: Typical Structure Connection



1.7 Bedding

The bedding material is placed in the bottom of the trench, between the foundation and the bottom of the pipe. The bedding allows for uniform longitudinal support and also distributes the load from the bottom of the pipe into the surrounding soil. The bedding thickness should be a minimum of four inches for 4"-36" diameter pipe and a minimum of six inches for 42"-60" diameter pipe. Recommended bedding material is a Class I, Class II, or Class III material as defined in Table 2 below. The use of class III bedding material is recommended only in dry trench conditions. Maximum particle size in the bedding material should not exceed 1½ inches. If bedding is to be used as an under drain, use a large, coarse, clean aggregate, not exceeding the maximum particle size.

The outer thirds of the bedding should be compacted and the middle one third portion should be loosely placed as shown in the Figure 7 below. This loosely placed area provides for uniform support at the invert.

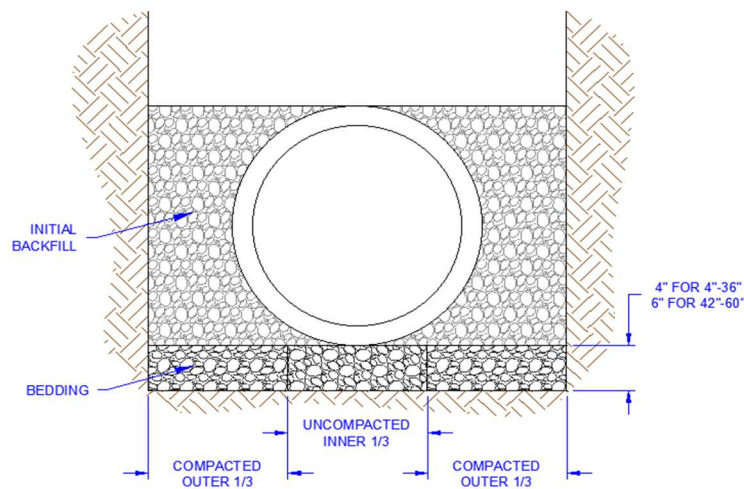

Figure 7: Bedding Placement

The bedding should be placed so that the pipe invert is at the correct grade when backfilled. It is important to note that there may be settlement of the pipe when placed on uncompacted or loosely placed soil. A backhoe bucket should not be used to press on the pipe to bring it to grade. Also, blocking or soil mounds should not be used under the pipe, as this will cause point loading.

1.8 Laying Pipe

Before pipe is laid into the trench, re-inspect the pipe for any damage and clean any debris that may have accumulated on the inside of the pipe or sealing surfaces.

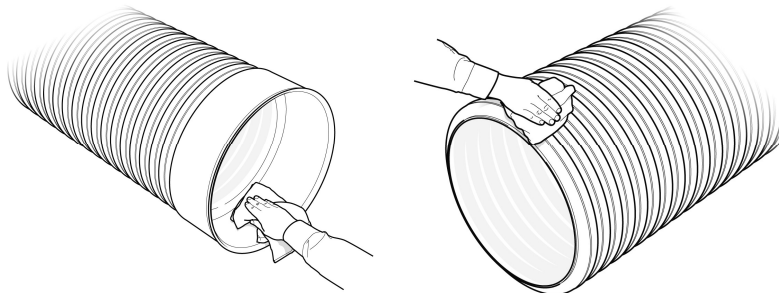

Figure 8: Cleaning Sealing Surfaces of Pipe



Pipe should also be checked to ensure that it is the correct type and size. The pipe should be lowered into the trench using slings placed in a manner that evenly supports the pipe. It is good practice to use a “tag line” when moving the pipe into position; this is a line attached to the end of the pipe, used to prevent uncontrolled pipe movement.

Pipe equipped with integral bell and spigots, such as Prinsco’s watertight dual-wall HDPE and PP pipe, must be installed by inserting the spigot into the bell.

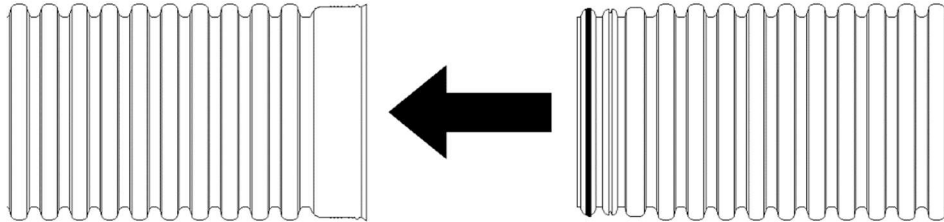

Figure 9: Integral Bell and Spigot Connection

Pushing the bell onto a spigot increases the likelihood of forcing bedding material into the joint, disrupting the gasket and severely undermining water-tight performance. With this in mind, pipe laying should begin at the lowest point of the project with spigots pointed down-grade. With the spigot ready to be inserted into the bell, remove the protective film around the gasket. Use a clean brush, cloth rag, sponge or gloved hand to apply approved pipe lube to both the gasket and the bell. Do not allow lubricated section to contact dirt or backfill. Foreign matter could adhere to the lubricated surface and compromise the joint integrity. Failure to properly lubricate the joint will adversely affect the joint performance and will increase the force needed to push the joint “home”.

Homing the pipe can be accomplished in a number of ways; smaller diameter pipe may be pushed together by hand or leveraged together using a spanner block and a lever as shown in Figure 10.

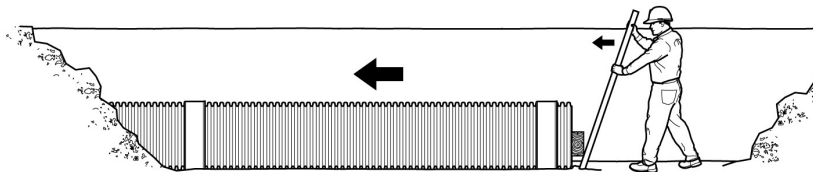

Figure 10: Installing Small Diameter Pipe

Larger diameter pipe typically requires more force to assemble which necessitates the use of machinery, such as a backhoe. One method of using a backhoe for assembly is to use the slinging strap to “pull” the spigot into the bell of a previously installed pipe, as shown in Figure 11.

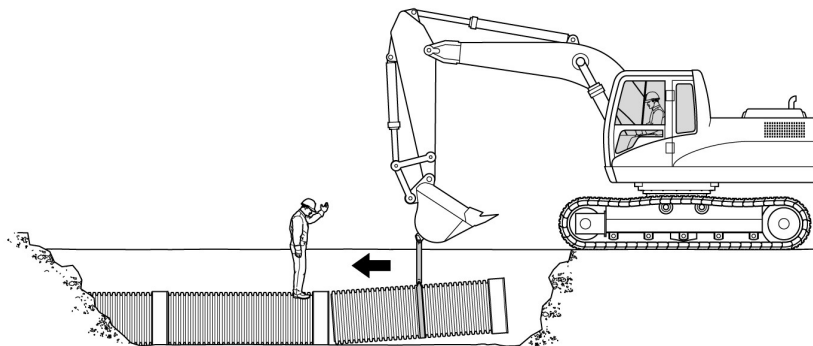

Figure 11: Installing Large Diameter Pipe with Sling



Another method involves pushing the pipe joints together. For this method, a sacrificial spigot or portion of pipe is placed inside the bell of the pipe to be installed, then the assembly is pushed into the bell of a previously installed pipe, as shown in Figure 12.

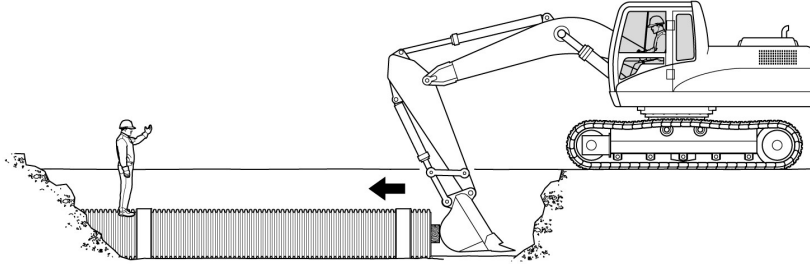

Figure 12: Installing Large Diameter Pipe with Stub

This sacrificial spigot/stub acts as a bumper to prevent damage to the pipe or bell from the bucket. When using machinery to assemble joints, caution should be used to assure joints do not slam together and that the pipe already installed is not shoved out of alignment. A spotter should observe the spigot insertion to signal the operator when the joint is completely inserted and to prevent “over-homing.”

During pipe joint assembly it is critical to ensure the pipe lengths are aligned both vertically and horizontally. Improper alignment will result in difficult or improper joint assembly and may cause the pipe joint to leak. If the misalignment is necessary for grade or curvilinear alignment a maximum of 1-degree misalignment is recommended.

1.9 Backfilling

The backfilling process is critical to ensure long trouble-free service. The backfill and pipe function together as a structural system, forming the pipe/soil envelope, to support the soil overburden and live vehicular loads. For this reason, the backfill material and level of compaction directly impacts the performance of the pipe/soil envelope. The backfill material must have a high density as well as a resistance to migration and degradation. Prinsco uses the soil classifications as described in ASTM D2321; these soil classifications and descriptions can be found in Table 2.



Table 2: ASTM and AASHTO Soil Properties

ASTM D2321		ASTM D2487		Percentage Passing Sieve Sizes			Atterberg Limits		
Class	Type	Notation	Description	AASHTO M43 Notation	1 1/2 in.	No.4	No.200	LL	PI
					(40 mm)	(4.75 mm)	(0.075 mm)		
IA	Manufactured Aggregates: clean open-graded	N/A	Angular crushed stone or rock, crushed gravel, broken coral, crushed slag, cinders or shells; large voids with little or no fines	5	100%	≤10%	<5%	Non-Plastic	
IB	Manufactured processed aggregates; dense-graded, clean	N/A	Angular crushed stone or other Class IA material and stone/sand mixtures; little or no fines	56	100%	≤50%	<5%		
II	Coarse-Grained Soils, clean	GW	Well-graded gravel, gravel/sand mixtures; little or no fines	57	100%	<50% of "Coarse Fraction"	<5%	Non-Plastic	
		GP	Poorly-graded gravels, gravel sand mixtures; little or no fines	6					
		SW	Well-graded sands, gravelly sands; little or no fines	67		>50% of "Coarse Fraction"			
		SP	Poorly-graded sands, gravelly sands; little or no fines						
	Coarse-Grained Soils, borderline clean/fines	e.g. GW-GC, SP-SM	Sands and gravels which are borderline between clean and with fines			Varies			
III	Coarse-grained soils with fines	GM	Silty gravels, gravel/sand/silt mixtures	Gravel and sand with <10% fines	100%	<50% of "Coarse Fraction"	12% to 50%		
		GC	Clayey gravels, gravel/sand/clay mixtures						
		SM	Silty sands, sand/silt mixtures			>50% of "Coarse Fraction"			
		SC	Clayey sands, sand/clay mixtures						
IVA	Fine-Grained Soils (inorganic)	ML	Inorganic silts and very fine sands, rock flour, silty or clayey fine sands, silts with slight plasticity		100%	100%	>50%	<50	<"A" Line
		CL	Inorganic clays of low to medium plasticity; gravelly sandy, or silty clays; lean clays						>"A" Line
IVB	Fine-Grained Soils (inorganic)	MH	Inorganic silts, micaceous or diatomaceous fine sandy or silty soils, elastic silts		100%	100%	>50%	>50	<"A" Line
		CH	Inorganic clays of high plasticity, fat clays						>"A" Line



Soil within the pipe/soil envelope should not contain any organic material, stumps, logs or limbs, man-made waste, debris, frozen soil, or any other unsuitable material. During the backfill process there should not be any rocks larger than the maximum particle size of 1½ inches placed in the pipe/soil envelope. Meeting the requirements for the soil in the pipe/soil envelope is critical to obtaining maximum structural performance and service life. Any changes to the material used should be approved by the specifying organization or engineer of record.

The pipe/soil envelope is divided into multiple sections, as shown in Figure 13.

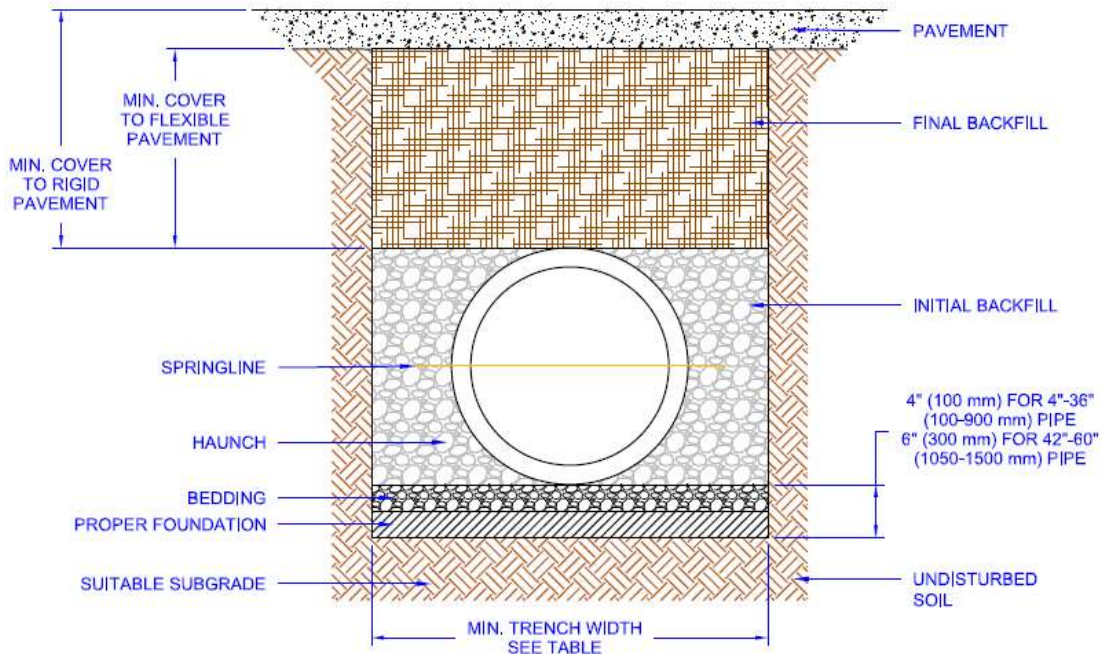

Figure 13: Typical Trench Installation

- **BEDDING**
 - The bedding is placed in the bottom of the trench, between the foundation and the outside diameter of the pipe.
- **HAUNCH**
 - The haunch is the area of initial backfill that extends from the bedding layer to the springline of the pipe.
- **INITIAL BACKFILL**
 - Initial backfill extends from the springline to the crown of the pipe.
- **EMBEDMENT**
 - The embedment refers to the zone of structural backfill around the pipe including the haunch and the initial backfill.
- **FINAL BACKFILL**
 - The final backfill is placed over the initial backfill and this material is used to build the trench up to final grade.

When beginning the backfilling process, the embedment material should be distributed and compacted in lifts evenly on each side of the trench to ensure that the pipe is not pushed out of alignment and help to prevent against elongation. Placing embedment material in the center of the pipe and allowing it to fall evenly on each side of the pipe is a method often used to maintain alignment of the pipe in the trench.



Compaction

Each section of the pipe/soil envelope should be compacted in lifts during installation. The type of material used will determine the height of the lifts and the degree of compaction necessary to achieve the desired pipe support. Table 3 contains the applicable compaction requirements based on soil types.

Table 3: Backfill Placement and Compaction Recommendations

	Class IA	Class IB	Class II	Class III	Class IV
General Recommendations and Restrictions	Suitable for use as a drainage blanket and underdrain in rock cuts where adjacent material is suitably graded. Should not be used where conditions may cause migration of fines from adjacent soil and loss of pipe support.	Process materials as required to obtain gradation which will minimize migration of adjacent materials. Suitable for use as drainage blanket and underdrain.	Where hydraulic gradient exists check gradation to minimize migration. "Clean" groups suitable for use as drainage blanket and underdrain.	Should not be used where water conditions in trench may cause instability.	Not Recommended
Foundation	Suitable as foundation and for replacing over-excavated and unstable trench bottom as cautioned above. Install and compact in 6-in. maximum layers.	Suitable as foundation and for replacing over-excavated and unstable trench bottom. Install and compact in 6-in. maximum layers.	Suitable as a foundation and for replacing over-excavated and unstable trench bottom as restricted above. Install and compact in 6-in. maximum layers.	Suitable as foundation and for replacing over-excavated trench bottom as restricted above. Should not be used in thicknesses greater than 12 in. total. Install and compact in 6-in. maximum layers.	Not Recommended
Bedding	Install in 6-in. maximum layers. Level final grade by hand. Minimum depth 4 in. (6 in.in rock cuts).	Install and compact in 6-in. maximum layers. Level final grade by hand. Minimum depth 4 in. (6 in.in rock cuts).	Install and compact in 6-in. maximum layers. Level final grade by hand. Minimum depth 4 in. (6 in.in rock cuts).	Suitable only in dry trench conditions. Install and compact in 6-in. maximum layers. Level final grade by hand. Minimum depth 4 in. (6 in.in rock cuts).	Not Recommended
Haunching	Install in 6-in. maximum layers. Work in around pipe by hand to provide uniform support.	Install and compact in 6-in. maximum layers. Work in around pipe by hand to provide uniform support.	Install and compact in 6-in. maximum layers. Work in around pipe by hand to provide uniform support.	Install and compact in 6-in. maximum layers. Work in around pipe by hand to provide uniform support.	Not Recommended
Initial Backfill	Install in lifts to top of crown, minimum.	Install in lifts to top of crown, minimum.	Install in lifts to top of crown, minimum.	Install in lifts to top of crown, minimum.	Not Recommended
Embedment Compaction	Place and work by hand to ensure all excavated voids and haunch areas are filled. For high densities use vibratory compactors.	Minimum density 85 % Standard Proctor. Use hand tampers or vibratory compactors.	Minimum density 85 % Standard Proctor. Use hand tampers or vibratory compactors.	Minimum density 90 % Standard Proctor. Use hand tampers or vibratory compactors. Maintain moisture content near optimum to minimize compaction effort.	Not Recommended
Final Backfill	Compact as required by the Engineer.	Compact as required by the Engineer.	Compact as required by the Engineer.	Compact as required by the Engineer.	Not Recommended

Notes:

See ASTM D2321 for a detailed description and classification of materials.

Layers should not exceed one half of the pipe diameter.



Class I, clean crushed stone, generally does not require compaction but an effort should be made to completely fill the haunch area and eliminate any voids. This is accomplished by “knifing” the material under and around the pipe with a shovel. Other materials require greater compaction; the level of effort should be determined by the project engineer or a geotechnical engineer based on the soil properties and the site conditions.

Care should be taken to avoid contact between the pipe and compaction equipment. Compaction equipment should not be used directly over the pipe until sufficient backfill has been placed to ensure the compaction equipment will not damage the pipe or cause deflection of the pipe.

Proper selection of compaction equipment depends on the type or backfill material being compacted. Table 4 below summarizes backfill material soils and its associated equipment type, and effort required to achieve compaction.

Table 4: Compaction Effort and Equipment

	Soil Classification ⁽¹⁾			
	Class I	Class II	Class III	Class IV
Effort Required	Low	Moderate	High	Very High
Equipment Type	Hand Knifing in Haunch, Vibratory, or Impact	Vibratory, or Impact	Impact	Impact
Moisture Control	None	None	Near optimum to minimize compaction effort	Near optimum to achieve required density
Maximum Lifts ⁽²⁾	18"	12"	6"	NA

Notes:

- 1) See ASTM D2321 or Table 2 for a detailed description and classification of material.
- 2) Lifts should not exceed one half the pipe diameter and may need to be reduced depending on the compaction method.

The desired compaction level may be achieved using common compaction equipment, which may include, but is not limited to: hand tampers, power tampers, static compactors, vibratory compactors or rammers. A few of the compactors are shown in Figure 14.



Vibratory plate equipment – Used for compacting non-cohesive backfill material.



Impact plate equipment – Used for non-cohesive and cohesive backfill material compaction.

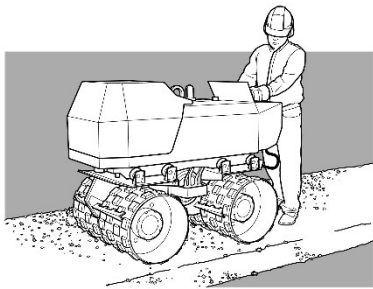

Self-propelled vibratory roller – Used for cohesive and non-cohesive material compaction.

Figure 14: Typical Compaction Equipment

To eliminate the possibility of damaging the pipe, a minimum of three feet of cover should be achieved before large, self-propelled compactors are used on or around the pipe. Hydro-hammers or other tractor mounted hydraulic vibratory and impact compaction equipment should not be used until a minimum of 4 feet of cover is over the pipe and then only if the embedment material design has been compacted to a minimum 85% standard proctor density.

Minimum Cover Height

Cover height is one of the determining factors when calculating the load carrying capacity of the installation. Minimum cover heights are dependent on the backfill material used and the expected live loads. With the minimum cover heights found in Table 5, Prinsco HDPE and HP pipe will withstand AASHTO H-25 and HS-25 highway loads:

Table 5: Minimum Cover Heights

Pipe Diameter	Minimum Cover Required ⁽¹⁾
4"-48"	12"
60"	18"

Note:

- 1) Minimum cover is measured from the top of the pipe to bottom of flexible pavement or to the top of rigid pavement.



These cover heights assume initial backfill to the crown of the pipe for HP and HDPE pipe with an additional layer of compacted sub-base material or rigid pavement to achieve the minimum requirements.

If the pipe will experience loading from relatively light construction equipment while the project is still being constructed, temporary fill may be placed over the pipe during construction and removed after the construction equipment traffic is rerouted. For construction loads between 30 and 60 tons, there should be a minimum of 3 feet of cover. For construction equipment exceeding 60 tons the minimum cover depends upon the loading footprint of the equipment. Additional fill may be required. For loads exceeding 60 tons, contact your local Prinsco Representative for minimum cover heights.

Often during the paving process, it is necessary to decrease the minimum cover heights. For temporary construction loads, such as pavers, the minimum allowable cover height is governed by the pressure at the surface of the soil which is a result of the vehicular load distributed over the tire contact patches. Table 6 illustrates minimum cover heights for temporary construction loads.

Table 6: Temporary Cover Requirements for Light Construction Traffic

Type of Vehicle	Vehicular Surface Pressure (psi)	Temporary Minimum Cover by Diameters	
		4" -48" Pipe	60" Pipe
Semi-tractor	75	9"	12"
Loaded pick-up truck	50	6"	9"
Skid steer loader	25	3"	6"

Note: Vehicles exceeding 75 psi of surface pressure must not be allowed over the installation with these temporary minimum covers.

Maximum Cover Height

Increased cover heights allow live load to be dispersed over a greater area of surrounding soil, however it also adds to the weight of the soil column directly above the pipe. Maximum cover heights are dependent on many variables including the pipe type, level of the ground water table, the backfill material used, and its level of compaction. Refer to Prinsco's *Structures Design Guide* for more information regarding maximum cover heights.

1.10 Additional Considerations

Geotextiles

To prevent the migration of fine soil particles into the pipe/soil envelope, the use of a geotextile may need to be considered. When the groundwater table is at or above the elevation of the pipe, fine particles from the in-situ soil have a tendency to migrate into the course backfill which can result in a loss of pipe support. The geotextile will act as a filter around the bedding, haunch and initial backfill and prevent this migration from occurring. Due to the wide variety of soil and site conditions, the use of a geotextile should be determined by a geotechnical engineer.

Dewatering

As previously stated, the properties of the in-situ soil surrounding the pipe envelope are very important for any pipeline installation. Standing water in an open trench greatly increase the likelihood of reduced structural capacity and make proper pipe placement and backfill compaction impossible. There are many methods to dewater, including: sump pumps, well points, deep wells, underdrains, stone blankets and diversion ditches. Each of these methods has their advantages and disadvantages; the specific project conditions should dictate the most appropriate dewatering method.



Groundwater/Pipe Flotation

Pipe flotation, due to buoyancy, may be a concern for pipe systems installed in areas where seasonal or permanent water tables extend beyond the pipe. This concern is exacerbated for watertight pipe systems and installations in poorly graded, non-cohesive soils. In all cases it is important to consider minimum cover heights necessary to prevent flotation. Depending on the site conditions these minimum cover heights may be greater than required for structural considerations. In applications where pipe buoyancy is too great for the soil load present, earth anchors or poured concrete collars may be used to secure the pipe to grade.

Field Modifications/Connections

As all projects are different, factory supplied pipe lengths may need to be altered in the field to comply with site requirements. Prinsco HDPE and HP pipe can easily be cut to the desired length using a hand saw, reciprocating saw, or equivalent tool. The cuts should always be made in a corrugation valley. To join field cut sections of HDPE & HP pipe, Prinsco offers Split Couplers in 4"-60" for soil-tight connections, and GOLDLOK® couplers in 12"- 60" for watertight applications.

On a given construction project there may exist a diverse range of pipe materials; whether extending an existing pipeline or connecting to a concrete manhole, there are numerous ways to connect Prinsco's pipe to dissimilar materials. Prinsco offers adapter fittings specifically for connections to corrugated metal pipe as well as concrete pipe and structures. Flexible couplings may also be used to adapt Prinsco pipe to smooth wall pipe types (clay, PVC, etc.). Prinsco's website, www.prinsco.com contains a comprehensive resource library of standard details. Contact your local Prinsco Representative for any questions regarding dissimilar connections.

Sealing Vent Tubes

Vent tubes are utilized during the manufacturing of HDPE and HP to release hot air from inside of the corrugations in order to properly form the corrugations. These tubes run the length of the pipe and are sealed on the ends during the manufacturing process. However, when field cuts are made, these vent tubes are exposed and present a potential problem for water-tight situations. It is recommended that these vent tubes are sealed to eliminate a potential leak path. Contact your local Prinsco Representative for information regarding sealing vent tubes.

Vertical Installations

Prinsco's dual wall HDPE and HP pipe are sometimes installed in vertical applications for use as catch basins or manholes. Pipe in vertical installations is subjected to different loading conditions than typical installation due to the pipe/soil interaction. Special consideration must be made for vertical installations. Additionally, vertical installations have a potential for flotation in areas of height ground water. Please refer to Prinsco's Catch Basin Form for more information on the installation requirements.

CAUTION: ANY VERTICAL INSTALLATION OF PIPE MUST BE SECURELY COVERED AT THE GROUND LEVEL. OPEN OR UNSECURED ENDS CREATE A RISK OF SERIOUS INJURY OR EVEN DEATH TO ADULTS, CHILDREN, OR ANIMALS WHO MAY ENTER OR FALL INTO VERTICALLY INSTALLED PIPE. PRINSCO ASSUMES NO LIABILITY FOR LOSSES RESULTING FROM FAILURE TO SECURELY COVER OPEN ENDS OR IMPROPER INSTALLATION.

Parallel Pipe Installation

In some applications, such as underground detention systems or high-volume fluid conveyance, it may be desirable to run multiple parallel pipelines in the same trench. In this situation, the trench width is a function of the number of runs, the adequate spacing between the pipes, and the adequate spacing between the pipe and the trench walls is shown below. For details on parallel pipe installations, see Prinsco drawing D-1-102 or contact your local Prinsco representative.

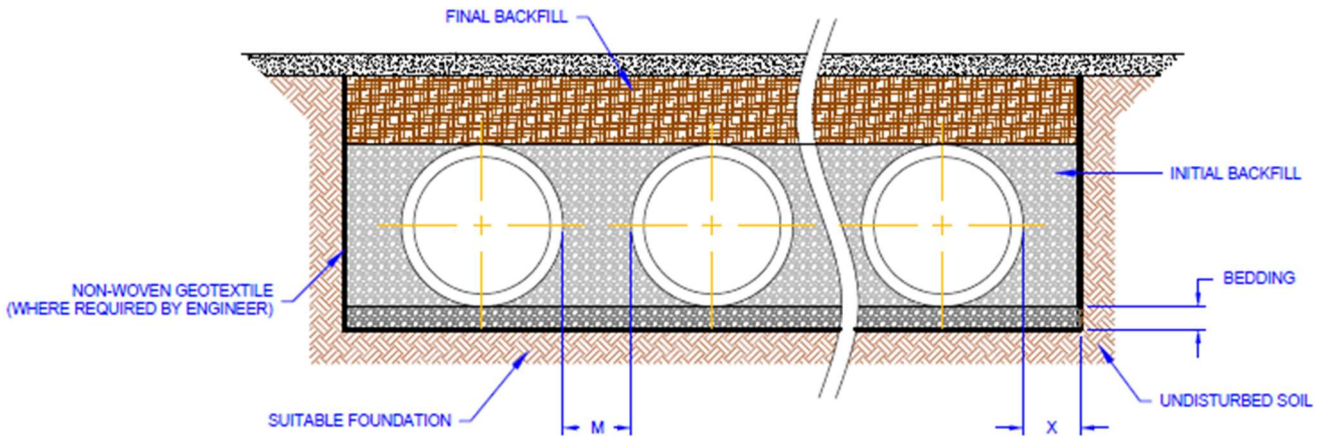

Figure 15: Typical Parallel Pipe Installation

Table 7: Parallel Pipe Installation Spacing

Nominal I.D. (in)	Minimum Spacing "M" (in)	Minimum Side Wall Spacing "X" (in)
12	12	8
15	12	8
18	12	9
24	12	10
30	15	18
36	18	18
42	21	18
48	24	18
60	30	18

Note: Minimum Spacing "M" measured between pipe outside diameters.

Soil Jetting

Soil jetting is a process by which a long hose or other device is worked down into the soil with a high velocity stream of water and is then pulled out slowly, compacting the soil as it is removed. Due to the relative light weight of HDPE and HP pipe, the soil jetting process could cause pipe floatation as well as disrupting the grade and line of the buried pipe. This process is not recommended for use with corrugated HDPE and HP pipe systems.

Deflection Testing

Deflection testing is generally not required when using proper construction practices associated with initial backfill material selection, placement, and compaction. However, if considered necessary, deflection testing can be performed per project specifications.

Some projects may require post installation deflection testing as a means of installation quality control. This is typically accomplished using a mandrel, laser measurement tools, or video inspection. Pulling a mandrel through 10% of the pipe installed provides a reasonable indication of installation quality. A typical mandrel is shown in Figure 16.

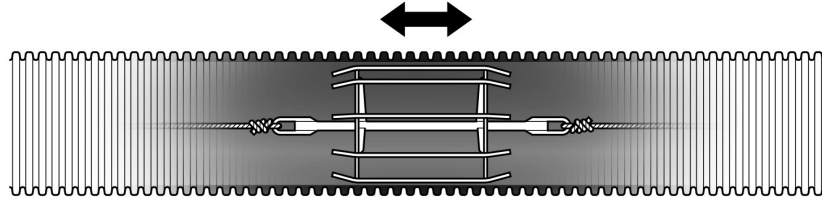

Figure 16: Typical Mandrel

Prinsco recommends a conservative maximum deflection of 7.5% of the base inside diameter (ID). The Base ID is a calculated value of the inside diameter that takes into account manufacturing variance as well as out of roundness from storage/handling. Table 8 should be used as a reference when using measurement devices such as mandrels or lasers:

Table 8: 7.5% Deflection Dimensions for Base Diameter

Nominal Diameter (in.)	Base I.D. (in.)	Vertical Height w/ 7.5% Deflection (in.)
4	3.87	3.57
6	5.80	5.36
8	7.73	7.15
10	9.66	8.93
12	11.60	10.73
15	14.50	13.41
18	17.40	16.09
24	23.20	21.46
30	28.99	26.81
36	34.79	32.18
42	40.59	37.54
48	46.39	42.91
60	57.99	53.64



While Prinsco recommends a maximum deflection of 7.5%, some project requirements limit deflection to 5%. Table 9 identifies the pertinent values based on the 5% criteria.

Table 9: 5% Deflection Dimensions for Base Diameter

Nominal Diameter (in.)	Base I.D. (in.)	Vertical Height w/ 5% Deflection (in.)
4	3.87	3.67
6	5.80	5.51
8	7.73	7.35
10	9.66	9.18
12	11.60	11.02
15	14.50	13.77
18	17.40	16.53
24	23.20	22.04
30	28.99	27.54
36	34.79	33.05
42	40.59	38.56
48	46.39	44.07
60	57.99	55.09

Results obtained from deflection testing can be easily misinterpreted, so findings should be thoroughly analyzed. Readings from either a mandrel or a laser device may be skewed for a variety of reasons unrelated to pipe deflection. For instance, debris in the pipe, joint misalignment or stubs that protrude inward into the pipeline may result in false negatives. In the cases where abnormalities exist in deflection results, video inspection should be performed prior to any rehabilitation efforts.

It is noted that corrugated HDPE and HP products are intended for the conveyance of fluids. Access into this product for inspection or other reason(s) should be done in accordance with OSHA recommendations for confined space entry.

1.11 Summary

Prinsco manufactures a variety of premium HDPE and HP pipe and fittings for use in water management applications. These products offer benefits in ease of handling, installation cost, jobsite safety, and service life. It is important to remember that the service life and installed performance of any high-quality pipeline installation is highly dependent on the methods used. This includes every portion of the installation process: material handling and storage, proper trench excavation, pipe placement, proper pipe connections, backfill material and compaction, and achieving minimum cover heights.

For any questions regarding pipe installation, contact your local Prinsco Representative.